

GYRO**ELECTRONICS CO.**

Largest specialist in R/C, offers the most complete line of equipment and accessories available from one source - and at lowest prices!

All GYRO transmitters and receivers meet latest U.S. Government regulations and are guaranteed to be as specified. An FCC examination is not required for this equipment.

GYRO'S tremendous stock assures shipment of your order within one day. Any Radio Control material not listed is also available for quick delivery.

Prices subject to change without notice.

In addition to the following partial list, GYRO even stocks a Walkie-Talkie!

GYRO ELECTRONICS CO.
36 WALKER STREET
NEW YORK 13, N.Y.
Return Postage Guaranteed



TRANSMITTERS
RECEIVERS
ESCAPEMENTS
ACTUATORS
SERVOS
PROPORTIONAL
MULTI CHANNEL
RELAYS
REED RELAYS
KITS
COMBINATIONS
DYNAMOTORS
MOTORS
VIBRATOR SUPPLIES
BATTERIES
CHARGERS
"B" PACKS
TUBES
CRYSTALS
TRANSISTORS
DIODES
ANTENNAS
METERS
TEST EQUIPMENT
SPECIALS
R/C BOOKS
DIAGRAMS
PLUGS & SOCKETS
SWITCHES
COMPONENTS
HARDWARE
TOOLS

BULK RATE
U.S. POSTAGE
Paid
NEW YORK, N. Y.
PERMIT No. 6539

New 1959 MOPA
POWERFUL

GYRO TRANSMITTERS

IMMEDIATE DELIVERY. The Most POWERFUL (5 Watt) TRANSMITTER at the LOWEST PRICE. Famous 2 Tube MOPA circuit, featuring GYRO MAGIC TUNING INDICATORS. Completely wired & tested, includes 9 1/2 ft. sectional Antenna, remote "clicker" Keying Switch, Meter, Beautiful Cabinet: 12" x 7" x 6". Available in following models—all with money-back GUARANTEE.

GYRO RX1 TRANSMITTER, as described, with built-in 2 volt Storage Battery, 2 V. Vibrator Supply. Complete \$38.65 with Battery Charger add **5.95** K 100

GYRO RX2 TRANSMITTER with built-in dynamotor to operate from car battery, 6V **\$35.95**; 12V **\$35.95** K 101

GYRO RX3 TRANSMITTER, as described but for dry battery operation. Complete (less batteries) ... K 102 **24.95**

1959 GYRO DELUXE RZT TRANSMITTER

Operates any 27 Mc STANDARD or AUDIOTONE (CG, Babcock, etc.) Receiver. The only high powered Transmitter offering both Standard & Audiotone Modulation—your choice by a flick of the switch; Tone Freq. Adj. 400-800 cycles, incorporates Ground Plane Booster plus all features of the famous MOPA Model RX1 w 5 WATT POWER - K 103 **only 49.50**



The Most Powerful Hand Held

R/C TRANSMITTER GYRO Model A-1

K 104

- Greatest Power—up to 5 watts input
- Greatest Distance—Range up to 3 sq. miles
- Gyro Magic Tuning Indicator—simplest tuning
- Versatile—operates from 90-180 Volts "B"
- Complete & Guaranteed—

Ready to Operate (less bttry) **\$17.95**; Complete KIT

\$11.95

Gyro R/C DeLuxe SPECIAL for Rudder, Elev & Motor Contr. Ready to Fly! Complete Gyro RX1 TRANSMITTER, Lorenz Receiver & Super Compound ESCAPEMENT **\$62.95** K 105

MODEL X MOPA 2-tube TRANSMITTER KIT, as used in Gyro xmitters, 3 1/4 x 3 1/4 x 1 1/2" Drilled Alum. Chassis w. Tubes & Crystal **10.95**
Wired, Ready to install in your case w. Magic Tuning Indicator **15.50** K 106



R/C BARGAINS

Lowest Price **R/C TRANSMITTER-RECEIVER Combination**

You Get Wired & Tested R/C RECEIVER Complete with K 107 Tube, Relay & Installation Kit, Plus the Most Powerful HAND HELD Transmitter Kit, Complete with Cabinet, Tube, Crystal **19.98**

SPECIAL #2: Wired & Tested RECEIVER, Wired & Tested K 108 TRANSMITTER & Self-Neutralizing ESCAPEMENT, Guaranteed 28.85

TRANSMITTER & RECEIVER KIT—Parts and diagrams (less tubes, crystal) to build Powerful Mac 2 Transmitter Unit & Famous LORENZ RECEIVER, with Sigma RELAY & drilled bases, wound coils. Res., Cap., Instr. **K 109 9.95**

LORENZ deluxe MOPA TRANSMITTER KIT with K 110 tubes, crystal, drilled chassis, wound coils, case, antenna **16.95**

CITIZENSHIP EQUIPMENT NOW AVAILABLE

from GYRO for IMMEDIATE DELIVERY:

ACTUATOR (Servos) TERRIFIC! Makes 4 Types KIT	\$11.95	K 111
Multi 8-Channel TRANSMITTER	99.95	K 112
8-CHANNEL REED RECEIVER	99.95	K 113
TRANSISTORIZED 465 Mc. RECEIVER	26.95	K 114
TRANSMITTER 465 Mc.	34.95	K 115

ALL TRANSISTOR RECEIVER

New all-transistor circuitry **K 116**

2.5 oz. with case and plug

Size—1" x 2 1/16" x 2 3/8"

Crashproof construction

3 volt battery operation

Ideal for pulse proportional

Very high relay current change **\$39.95**

Diagrams: any one of following .19

RECEIVERS: Miller, Lorenz, Trans-

istorized Lorenz, Lorenz Doubler,

Mini Mac, Simple single, Simple

gas tube.

TRANSMITTERS: Mac II Gyro Director,

Lorenz MOPA, Gyro ZT.

MISCELLANEOUS: Prop. Pulser, Prop.

actuator, 6 tone modulator, 3 tone

modulator, WAG prop. pulser, Trans.

prop. pulser, Escapement & actuator

hookup, 2 Volt charger, 2 Volt

Vibrator supply. **K 117**

GYRO 22X RECEIVER WINS FIRST & FIFTH PRIZES AT 1958 MAMMOTH MIRROR MEET

GYRO 22X only 22 1/2 Volts "B"—TERRIFIC!

2-Tube HARD TUBE RECEIVER: NOT AFFECTED BY TEMPERATURE

GYRO Model 22X (less relay) \$16.95; Dealers Inquiries Invited

(This Receiver is ideal for BABCOCK TRI-PACER)

- SMALLEST & LIGHTEST Install. of any set.
- Only 2 oz. incl. adjustable relay
- Idles at 1/2 Ma. Rises to 3 Ma. on Signal
- SUPERSENS Long Life Non-Critical Circuit
- Follows Fast Pulsing—No Delay
- Identical Circuit Praised By LORENZ & AERO-MODELER Magazine
- In Rugged Plastic Case 1 1/4 x 2 1/4 x 1 3/4 in.
- Uses 2 Hard Tubes
- Factory Wired, TESTED & GUARANTEED including INSTALLATION KIT



w. built-in Relay add 4.95

K 148

Lorenz RECEIVER 2-Tube

Wired & Tested

Supersensitive Non-Critical Circuit

Idles at less than 1/2 Ma. Relay current rises up to 3 Ma. on signal



Improved 1958 LORENZ RECEIVER: Idles at 1/4 Ma. & up to 5 Ma. on signal. Basic Kit w. wnd coils, dr. base, res., cap., diodes, pots, pl. & jack, switch, etc. \$4.95; with 2 Tubes \$10.95; with Relay \$14.98; Wired, Tested \$19.98

Wired & Tested, Complete Including TUBES & RELAY! \$18.95

Basic KIT with Drilled Base; Wound Coil & Choke 3.35

Compl. w. RK-61 & XFG-1 \$9.85; w. Tubes & Sigma 4F Relay 13.95

K 119

GAZISTOR

- Housed in Rugged Plastic Case
- Follows fast pulsing
- Lowest Battery Drain
- Relay current rises up to 3 Ma. on signal
- TINY 1 1/4 x 2 1/4 x 1 3/4 in., WEIGHS 2 oz. including relay.
- 7,000 hrs. Transistor life, very long tube & battery life.
- Sensitive—Reports better than 3 sq. mi. range (w. Gyro X-mitter)
- Transistor not damaged by hardest landing!
- Factory wired & tested complete

Only 50 Ma.

Factory Wired, TESTED & GUARANTEED including INSTALLATION KIT WITH RELAY \$19.95

KIT. w. sub. mini Pot wound coils, drilled base 4.75 with tube & Transistor \$8.95 with relay 13.20



K 120

GYRO SPECIAL Complete R/C RECEIVER

Lowest Cost! Wired & Tested. NOT A KIT! 27 1/4 Mc with Tube, Relay & Installation Parts. Tiny, 3 oz.



K 121

including INSTALLATION KIT

\$8.61

RADIO CONTROL RECEIVER KITS 27 1/4 Mc

NOTE: All GYRO kits are guaranteed complete deluxe types with diagrams—nothing else to buy!

- Lorenz 2-Tube w. Drilled Base; Wound Coil & Choke 3.35
- Compl. w. RK-61 & XFG-1 \$9.85; w. Tubes & Sigma 4F Relay 13.95 K 122
- MINI-MAC w. MINI Quench Coil, Wound Coils dr. Base, etc. 4.25
- Complete with Tube and RELAY 11.35 K 123
- MILLER or SIMPLE SINGLE with OSR type QUENCH COIL & Wound Choke \$4.45; Complete with Tube & SIGMA 4F Relay 9.85 K 124
- GAZISTOR w. sub. mini Pot wound coils, drilled base 4.75
- with tube & Transistor \$8.95 with relay 13.20 K 125
- NEW! RECEIVER INSTALLATION KIT Deluxe .85 K 126

New 3-Reed RECEIVER KIT—Pearce (MAN Jan. '58) Basic Kit incl. drilled base, wound coils, sockets, capacitors, chokes, plugs and jacks, etc. 6.55

RELAYS:

SIGMA RELAYS:



4F 10,000 ohm 4.95;
8000 ohm \$5.98;
2500 ohm 4.95
4F REPLAC COIL
with Pole Piece 1.95
10,000 ohm 1.15
3000 ohm 2.95;

K 230

5F \$3.95

16,000 ohm in dual
8,000 ohm coils.
(Can be paralleled)

SPDT, K 231

11F 6000 ohm
SPDT, 2.50

pulls in at 3 ma.

K 232

41F 10,000 ohm 1.45

SPDT K 233

SUB MINI GEM RELAYS:

Gem Micro Adj. 5K \$4.95; 7500 5.95 K 234
Gem 5000 ohm \$4.25; 7500 ohm 5.45 K 235
Gem DPDT 5000 ohm 6.25; SPST 100 ohm 4.95 K 236
Gem DPDT 7500 \$6.85; DPDT 100 ohm 4.25 K 237



NEW! Tiny "MITE" Mini RELAY
less than 1/2 oz., 3/4" h. x 1/2" w. x 1"
5000 ohm, SPDT, 1 1/4 Ma Pullin

only 2.5v
K 238

G. E.: 2 ma; SPST
10,000 ohm; 1.25

RELAYS:

REED RELAYS
Adj., with instr.:

Gyro K 239
8 Reed 17.95
6 Reed 14.95
3 Reed 13.95;
K 24C
Dean 8 \$22.50
5 19.95



"Peanut Size" K 241

6 Volt \$1.45:



K 242
Polarized 7.50
4,500 ohm
pulls in
at .8 ma.

ADVANCE K 243
Type 50 5.45

adjustable
to 1 ma.



K 244 BK 7

2.95

4,000 ohm
1/2 ma. pull in.

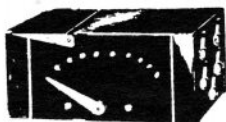

Mini K 245

1 1/2 - 3 Volt 100 ohm
2.50
4 - 12 Volt 450 ohm
1.25



Relay CONTACT CLEANER Burnishing Tool .70

K 246 Reverse-Stop Relay for Boats

3.25

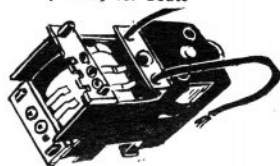

BB54, K 165
2 VOLT 3"x4"x5 1/2"
27 Amp/Hr. 4.25



NT6 Mini 6 VOLT, K 167
2 1/2"x1 3/4"x3 1/2"
4 Amp/Hrs. 3.45



K 169 Mini 2 Volt
3/8"x1 1/8 in. .75



SILVERCEL

YARDNEY 1 1/2 volts, 1A/Hr.,
LR-1: 1"x1/2"x2"..... 6.00
Rechargeable K 168

NEW! 2 Volt, 10 A/hr STORAGE BATTERY K 171 3.50
Lifetime Nickel Cadmium STORAGE BATTERY K 172
standard types available

Imported STORAGE BATTERIES:
2 Volt 3A/hr 2 1/4"x3 3/8"x1 1/4" K 173 1.75
2 Volt 6A/hr. 2 3/8"x1 3/8"x4 1/2" K 174 \$2.75
Tiny Sizes: 2V 1 1/2 A/hr. 1 5/8"x7/8"x1 3/4" K 175 \$1.25
2V 2 A/hr 1.30 K 176 Small 4V 1 1/2 A/hr K 177 \$1.65
6V, 4 A/hr. NT6 size K 178 4.75

BATTERY CHARGERS

CHARGER for Silver Cells or Flashlight Cells Complete K 179 3.95
CHARGER RESISTOR: Charge 2-6V. Btry. from Car Btry. .25
2-6 Volt, Wired/Tested 6.95; Kit 4.95
K 181

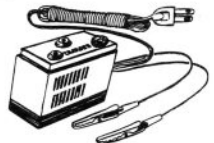

K 183
CHARGER for DRY BATTERIES. Use 1 set of A & B's all season!
Recharges all Dry Batteries; 1 1/2 to 90V. up to 5 times 4.95

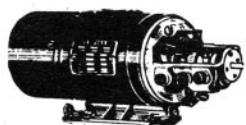

DYNAMOTORS:

6 Volts Input 150 Volts Output @ 100 Ma 6.95 K 184
6V/180V @ 100 Ma 7.95 K 185
6V/12V-150V/300V @ 100 Ma. 9.95 K 186

STOP WASTING MONEY on dry batteries for your transmitter.

Add our 2-VOLT VIBRATOR SUPPLY to any transmitter;
output 135 to 180 V.; Wired & Tested 10.95 K 187
2 VOLT VIBRATOR SUPPLY KIT K 188 6.95
with drilled base; Transf., etc.
Mini 6V VIBRATOR SUPPLY 90V K 189
15 Ma. Complete 3.45
Vibrators: 6V. \$1.35; 2V Synchronous 1.25
Brand New. 2 V. VIBRATOR X-FORMER,
180-135 V @ 40 Ma K 190 3.50



NEW MODEL RECEIVER "B" PACK
Suitable for use with Reed
Receivers. 30 Volts up to
20 ma. K 191

Kit 6.95
Wired & Tested 11.95

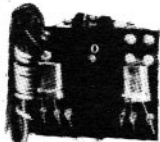

NEW GYRO "B" PACK for RC Receivers

30, 45 or 67 1/2 Volts from Pencells
STOP Buying Expensive "B" Batteries!
Delivers 30 or 45 or 67 1/2 Volts from Escapement Battery.
Tiny. Only 1 1/4"x1 1/2". 1/2 oz. \$5.95
Complete KIT with Transformer, Drilled Base, Parts &
Simple-to-Make Instructions (less transistors) K 192
COMPLETE. Wired, Tested, Ready to Operate 30, 45 or 67 1/2 V. 10.9

"B" PACK for TRANSMITTERS New Low Prices • Input
4 Volts (or 6V) • De-
livers 135 Volts up to 30 Ma. • 5 oz. only 2" x 3 1/2" x 1 1/4".
• Fits into all hand-held transmitters.

COMPLETE KIT with Mini Transformer, diodes, drilled bases, capacitors, resistors, instr. (less transistors) 12.95
WIRED & TESTED with Transistors, guaranteed 19.90
With VOLTAGE REGULATOR for Reed Transmitters add 3.75 K 193



ARISTO - REV
1 1/2-3V \$3.50 K 194
3-1 1/2 V \$2.95 K 195

MOTORS

MIGHTY MIDGET Electric MOTOR With Gear 2.95
Extra GEARS: Large 30c; Small 15c; Brush 25c pr.

5 Most popular type for K 197
use with model boats. 4.95



"TINY ATOM" ELECTRIC MOTOR, K 196
1 1/2 volt at .28 amp. 6000 RPM .187 in.
oz. torque, 1/2000 H.P. 1.75
MOTOR with variable speed gear box. 3.45



PITMAN
6V MEDIUM POWER \$6.75 6V HEAVY \$8.50
K 201 K 202

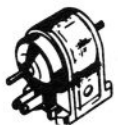

K 198 #.01 . . 1.5 to 3V \$7.0
K 199 #.0 . . 1.5 to 4V \$1.00
K 200 #4 . . 3 to 8V \$2.45





K 145

GEAR BOX 800:1 Ratio 2 1/2" DX 2" -
up to 5,000 RPM 1.45



RELAY CONTROL UNIT K 147

Incl. sensitive 10,000 ohm Sigma relay (1 1/2 ma)
Thermal Bimetal Strip, Heating element, Hi Z
audio choke, Mini Alnico V magnet, Neon Lamp,
Resistors, Capacitors 1.45

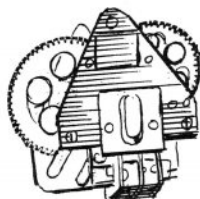

AUDIOTONE MODULATOR: Convert any Transmitter to Audiotone K 148
Operation in Minutes. (Will operate Babcock, WAG, 1/2-Tone,
etc.) Complete, Ready to Use. Guaranteed 7.95



FLEXIBLE KEYING LINE 2.95 K 149

Telephone type RETRACTABLE cord
extends to a full six feet.
Comes completely assembled with
JACK and "CLICKER" KEYING SWITCH.

STANDARD KEYING LINE 1.95

Comes completely assembled with
JACK and "CLICKER" KEYING SWITCH.



FLIPOUT R/C ANTENNA: 11 oz. 10 1/2 ft. collapses to 17"
with base. lightweight, fits in pocket K 150 3.75

WHIP ANTENNA, 3 sect., 9 1/2 ft. 1.85; with base 2.75 K 151

Gyro base only \$.85 K 152

Gyro 6ft. with base \$1.95 K 153

32 ft. sectional whip \$6.95 K 154

BABCOCK'S "THE TRI-PACER"



K 155

Complete Kit Contains

Pre-formed parts of revolutionary
new Hi-Impact plastic . . . impervious
to fuel damage
Realistic shock-absorbing wheels. . . .
Pre-formed landing gear
Full-size easy to read drawings . . .
Detailed instructions for assembly,
installation of R/C equipment and
flying

37" WING SPAN

Easy to build in a single evening
All plastic R/C flying model

BUY IT TODAY . . . FLY IT TOMORROW!

ONLY 9.95

BATTERY HOLDERS:

2 Pencil & 2 "B"

HILLCREST

Nylon 4 Pencil

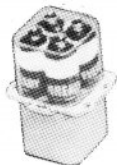
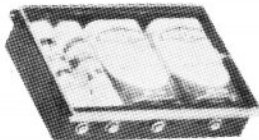

K 156 ACME Pencil-Single 30c; double .50
K 157 Triple 65c; Quaduple .85
K 158 Med. "C" Size-Single 40c; Dble. 50c; Trpl. .85
K 159 Flashlight "D" Single 40c; Dble 50c; Trpl. .85
K 160 Mini 22 1/2 Single 40c; Double 50c; Triple .85
K 161 Ectron Multi Pak \$1.65-ALL TYPES AVAIL.
K 162 HILLCREST Plastic 2 Pencil & 2 "B" .95
K 163 4 Pencil & 1 "B" 95c; Nylon 4 Pencil .95
K 164 6 Pencil 95c; Double "C" 45c; 3 22 1/2V .95

ACME

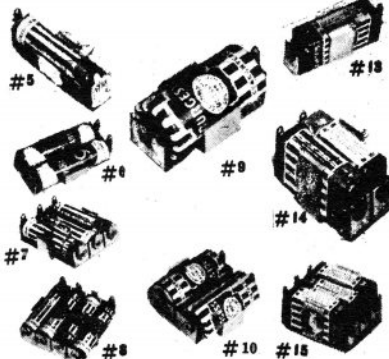

PROPORTIONAL CONTROL COMPONENTS

Galloping Ghost ACTUATOR, K 128
provides dual prop. control of RUDDER
AND ELEVATOR. Compl. only 9.95

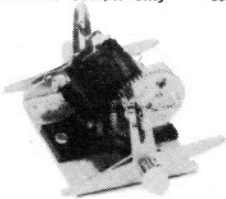

Flyball \$2.45; K 129
with motor 4.95

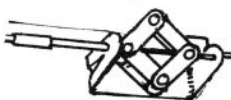

Prop. ACTUATOR K 130
(Powertui Mactuator Style) 5.95



Southwestern 5.95 K 131



ELECTRONIC (no tubes) PULSER KIT:
compl. with Relay, Case,
All Parts & Instr. Provides Prop.
Rudder, Motor Control

6.95
K 132



W.A.G.—McEntee Circuit

NEW! Gyro TINY PULSER Dual Proportional K 133
in small case w. two 1AG4 Tubes & New Relay.
Factory Wired & Tested \$17.75; KIT 13.75

Set of 4 GEARS
w. Instr. to make
McEntee's Prop. Joystick
2.50



WOUND ACTUATOR COILS.
Small 14 ohms 2 for .65

K 134



GYRO SPECIALS

7

MODEL RAILROADING EQUIPMENT

GYRO 3 Pack - runs 1 to 6 Loco's
3 spd. controls . . . 3 center off
rev. switches .. two meters, circ.
breakers, pulse power . . . 9x5x6
K 135 case 33.50

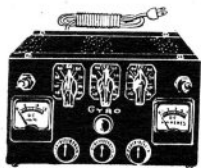

K 136 12-24V. Generator 12amp. New 9.95

K 137 16V. transformers 2A 1.65 4A 3.95

K 138 Selen. Rectifiers 1 amp. 1.50

2 amp. 2.40 4 amp. 3.75

K 140 40 ohm rheostat control
50 Watt 1.95

K 141 5 Loco power kit includes 4 amp.
rect., pulse power, switch, fuse
wire & diagrams 8.95

HANDIE-TALKIE . . . TWO METER BAND

Basic transmitter and receiver K 142
chassis. New WIRED with DUAL TUBE. 7.65;

ACCESSORIES

1- Aluminum cabinet, 12" long, with
mounted battery holder, on-off
switch and antenna jack and plug. 3.95

1- Snap Fastener, for "B" batteries. .20

2- Small knobs @ \$.10

1- Earphone, high impedance magntic with
built in mounting screws and two support-
ing nuts and screws. 1.45

1- Antenna Coil and Hookup Wire Kit, 2 1/2"
solid insulated wire; 3/4 6-32 screw; .15
2 flat washers; 1 split washer; 2 nuts;

4 colors stranded hookup wire, 1ft. long
1- Transformer, microphone, high gain shield-
ed, with bracket and screws. .98



MINIATURE K 143
TELESCOPING
ANTENNA 1.49

For miniature pocket and
transistor radios. Transceiver
Applications and Amateur use.
Made of chrome plated brass,
antenna has 5 sections—pulls
out to 38 inches extension
plugs into jack provided. Re-
tracts to 9 inches for carrying
in pocket. Flexible plastic case
with protecting flap included.



"Hearing Aid"
Type Earphone K 144
1.95



Earphones -
high impedance
2.25



K 208 **Stop Counting Pulses! PILOT CONTROL BOX**

for Varicomp, Babcock Mark 2, Compound, DeBolt
2PN & 3PN Servos. Compl., Ready to Operate in
Small Case 12.95

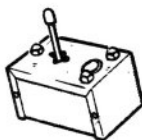

K 209 **JOYSTICK CONTROL BOX: 5-Position DIVE—CLIMB—LEFT
—RIGHT—ideal for Multi-Channel and Motor-Control Use
—5 Micro Switches 3½x2½x3¼ in.—Made by GRUM-
MAN for Automatic Pilot** 3.95

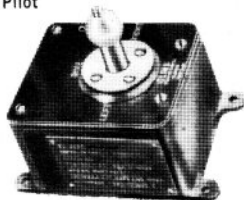

BABCOCK:

K 203
Mtr. Contr. 8.95

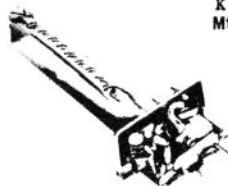

K 204
8-pos. Rev. Relay 8.95;

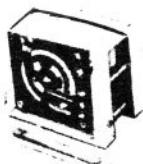

K 205
prop. Servo 14.50



K 206
Super Comp. \$7.95;



K 207
Elec. Servo 8.95
for boats



Super Aerotrol 3.95
K 210



Bramco Throttle \$4.95;
K 211

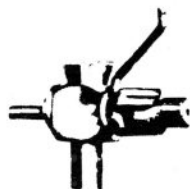

Roto Valve 2 Sp. 4.95
K 212



Aristomatic—For'd. Rev., Rt., Lft., Stop 10.95
K 213



for boats

K 214 TELEPHONE STEPPER RELAY:
10-Pos. 2-Deck 6V 12.95

**TELEPHONE
IMPULSE DIAL**

To open a normally closed
circuit. Ten holes — capac-
ity: 1-10 impulses. 3.50
K 215

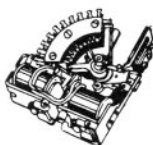

K 216 ED Mark III..... 5.95

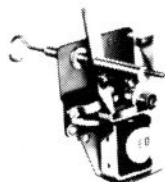

SLIM LINE SERVO

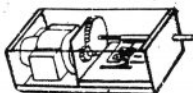
Self neutralizing or trim
\$8.95 K 217

Aristo Actuator K 218 10.95

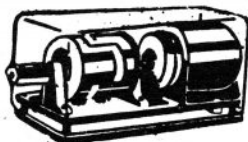
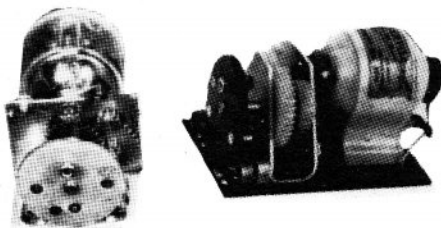
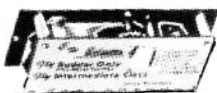
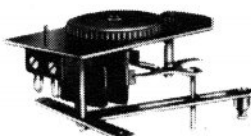
MIGHTY MIDGET Electric MOTOR With Gear 2.95 K 219
Extra GEARS: Large 30c; Small 15c; Brush 25c pr.DeBolt Servos 2PN \$11.95; 3PN 14.95 K 220
2P2N \$11.95; MCR or MCE \$18.95; 3P 10.95"SELECTOR 4" Simultaneous RUDDER & ELEVATOR CONTROL 8.95
K 221Clockwork Escapement 11.95 K 222
Ideal for marine use.

BONNER:

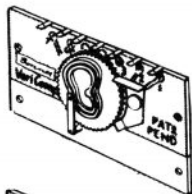
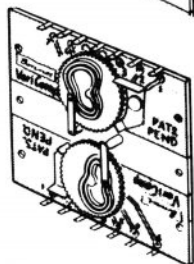
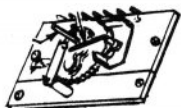
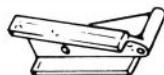
K 223
Servo 14.95;K 224
VariComp. 8.95K 225
Dual VariComp 18.95K 226
Reg. \$5.95;.K 227
Rudder Elev. VariComp 8.95K 228
Bonner CONTROL HORN 25c;K 229
TAIL WHEEL BRACKET .50



TUBES

CRYSTALS



TRANSISTORS

Diodes:

Guar. New! CK1054 RK61 \$3.30 • XFG-1 \$2.95 • 3D6 \$1.25 • 1AG4 \$3.20 • 6007 \$1.95

CK526 2.85 3A5 .95 1U4 .95 1S4 1.15 1V5 2.95 3V4 1.25 3Q4 1.10
3B7 .95 3B4 2.95 1U5 1.25 CK722 .99 3A4 1.25 1AH4 1.35 3S4 1.25

CRYSTALS: 27.255 Mc. Guar. 2.85; Canadian 27.12 Mc. 3.95
27.255 Mc Peterson Z9A 3.95; 13.6275 Mc \$3.95 HOLDER .15

5 NEW Frequencies:

26.995, 27.045, 27.095, 27.145, 27.195.
CRYSTALS in stock for all 5 Frequencies \$3.95 ea.



GYRO TRANSMITTERS & RECEIVERS are ADJUSTABLE to the NEW FREQUENCIES.

TRANSISTORS 2N273 2.30; SB103 27Mc 6.95; A0-1 1.90; Diodes: 1N295 65c; 1215 .65 ITI 65c

METERS

FIELD STRENGTH METER K 247

All Transmitters Need FIELD STRENGTH METER
KIT with crystal & wound coil, 27¼ Mc. 1.35
w. 0-3 Ma. Meter \$3.75; Wired & Tested add 1.00



Tiny 1" METERS: Your Choice 4.95 Ea.: 0-1 Ma; 0-5 Ma; or 0-50 Ma. K 248
METERS: Accurate 2" sq. 0-3 Ma. \$2.95; 0-5 Ma. 3.75 K 249
0-50 Ma. \$2.25; 0-½ Ma. \$3.95 0-1 Ma. 3.65 K 250
NEW! 10 Ma. METER 5.25 K 251
NEW! COMBINATION 5 Ma & 50 Ma METER w. switch 5.25 K 252



K 253 RC MULTITESTER—Pocket Size, 11 Ranges, Tests Volts
AC/DC, Milliamps, Resistors, etc. complete 10.95
K 254 COMBINATION R/C MULTITESTER. Complete Checks Field
Strength 27¼ Mc; Resistance: Volts, Milliamps 12.95

Double Voltmeter 2V & 50V ranges K 255
handy battery tester 3.75

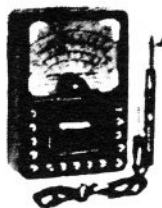

RADIO CONTROL BOOKS:

New Reference Handbook 2.00

Basics of RC 35c; Application of RC .50
Commercial RC Circuits .50
Radio Control Handbook—McEntee 2.25
Radio Control for Model Boats—McEntee 1.00
Electronic Hobbyists Handbook—Turner 2.50
Model Control—Safford 1.00
RC for Model Aircraft, Boats—Berkeley 1.00
Radio Control Mechanisms—Stock 1.25
Transistor Circuits—Turner 2.75



Transistors Theory & Practics—Turner 2.00
RC of Model Aircraft—Sommerhoff 2.50
Simple Radio Control—Hundley 1.40
R/C of Models—Sommerhoff 1.40
R/C for Model Ships & Aircraft—Judd 2.40
R/C Models for Amateurs—Kerney 1.40
Model Boat R/C Control—Casebook 1.65
Electronic Puzzles and Games—Mandi 1.95

WIDELY USED R/C TUBES

Always read tube and socket leads clockwise looking at bottom -

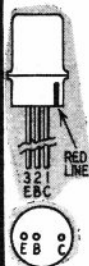
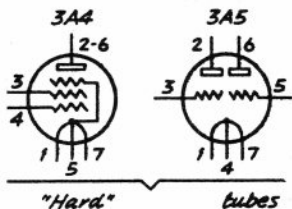
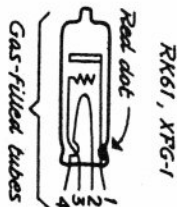

TRANSISTORS

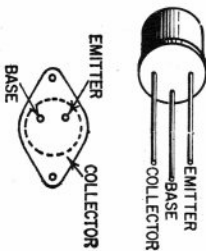

RESISTOR & CONDENSER COLOR CODE

Resistor-Condenser Color Code

Color	Significant Figure	Decimal Multiplier	Tolerance (%)
Black	0	1	-
Brown	1	10	1*
Red	2	100	2*
Orange	3	1000	3*
Yellow	4	10,000	4*
Green	5	100,000	5*
Blue	6	1,000,000	6*
Violet	7	10,000,000	7*
Gray	8	100,000,000	8*
White	9	1,000,000,000	9*
Gold	-	0.1	5
Silver	-	0.01	10
No color	-	-	20

Examples: A resistor of the type shown in the lower drawing has the following color bands: A, red; B, red; C, orange; D, no color. The significant figures are 2, 2 (22) and the decimal multiplier is 1000. The value of resistance is therefore 22,000 ohms and the tolerance is $\pm 20\%$.

mica condenser markings:
1st. fig. 2nd. fig. Read left to right in m.m.f.



Ceramic condenser markings:
1st. fig. 2nd. fig. Read left to right (wide band at left) in m.m.f.
Multiplier
Extreme left & right bands show temperature coef. & tolerance -

Example: A ceramic condenser has the following markings: Broad band, violet; narrow bands or dots, green, brown, black, green. The significant figures are 5, 1 (51) and the decimal multiplier is 1, so the capacitance is 51 μ fd.

resistor markings:
1st. fig. 2nd. fig. Read left to right in ohms
Multiplier tolerance

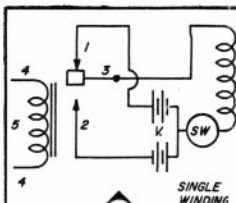

ACTUATOR

HOOK UPS

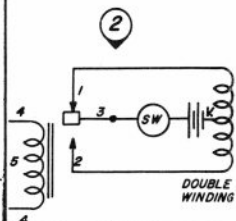

DOUBLE WINDING

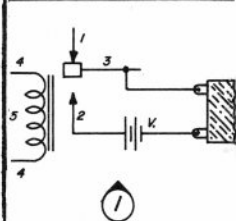

ESCAPEMENT

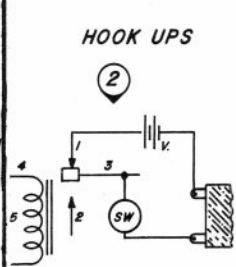

HOOK UPS

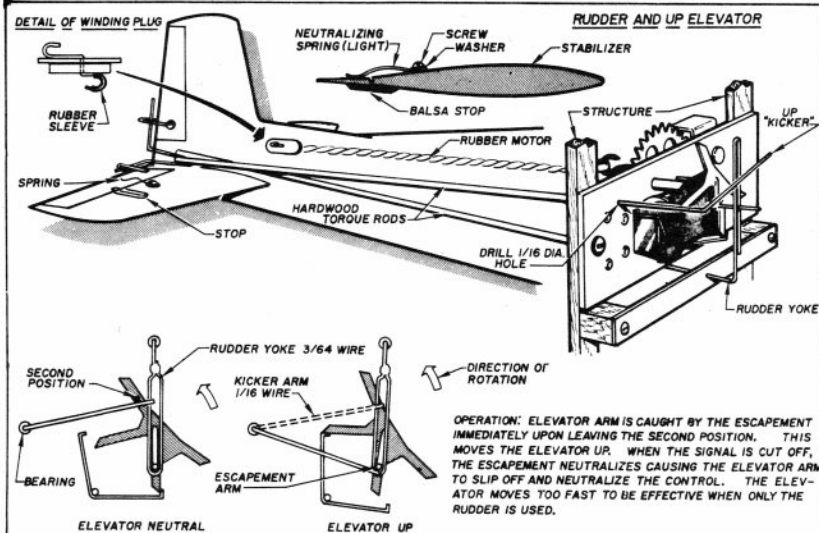

SIMPLE R/C HOOK-UP

FLYING MODELS

Tube Sockets,

Octal

Wafer 10c;



Molded .15

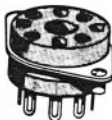

Loktal15



3 or 4 pin pr. .15



4 pin chassis mount
plug & socket .15



**7 pin
printed circuit
socket**

.25

Mini 7 Pin

6 pin pr. 30c;
5 pin pr. 25c;



Wafer 10c;



Molded 15c;



Mini 7 pin pr. .40



Hearing Aid: 3, 4 or 5 pin .15



CRYSTAL HOLDER .15



9 pin pr. 25c;

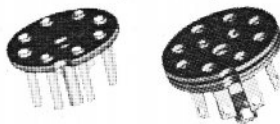

New 9-Pin Mini Plug & Socket, pr. .55



PLUGS & JACKS

Single Contact
plug & socket
per pr. .10



Tiny phone Jack:

closed .25



Open .25



**3 CIRCUIT PHONE
PLUG & JACK**

PLUG .75

JACK .35

Standard Phone Jack.



Open 30c;

Tiny plug for Above Jacks .30



closed .35

Phone Plug for Above .35



PLUGS & JACKS: Mini RCA pr. .15
Closed Circuit Jack .20



PLUG & SOCKETS w. Gold-Plated Pins, Locking Type.
(Lists @ \$6 pr.)

14 Pin \$2.45 pr.;



7 Pin \$1.95 pr.;



22 Pin pr. 2.75

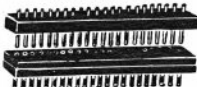

SWITCH—SLIDE

SPST 15c; DPST 20c; DPDT .25

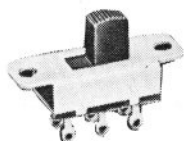
TOGGLE:
DPST 45c;

DPDT .65



SPST 30c;

SPDT
Center Off
One Side Momentary .25

Push Switch .35

Keying Switch,
panel mount click type
Normally open .85
Normally closed .85Sub Mini
Push Switch .451SM1 MICROSWITCH
\$ 1.35Keying Switch:
Remote micro "Clicker" .85Limit Switch Contacts
.10

Rotary Switch .25

Economy panel switch
.25Rotary Wafer Switch
2P3T .65Delux Keying Switch - fits palm
of your hand perfectly "Clicker"
type 1.95PANEL MOUNTING
Keying Switch
Normally open .45

LAST MINUTE ADDITIONS

ZERO CENTER SCALE Milliammeter (uncalibrated)0-1 Ma 2.95
 Coiled PHONE CORD extends 6 ft., 4-wire, for keying 1.45
 NEW! Gyro 8-REED RELAY—adjustable 17.95

Airplane Silk - lightweight,
strong, white special .95 per yard

CODE-PRACTICE OSCILLATOR & BLINKER KIT
less fones..... .95

Test Probes
.50 pr.



7 pin molded
Vibrator Skt. .25

COMPONENTS

Potentiometer:
50,000 or 100,000 ohms .50
Mini 10,000 or 25,000 ohm .40



Pots—Allen Bradley Linear
100K or 1 Meg 1.00
also other sizes.



Pot. Dime-Size,
1/4 or 2 Meg..... .85
50K or 100K ohm... 99c:
10,000-25,000 ohms99



PADDER.
For Simple Single or Mini Mac. Sets
.60



Ceramic Trimmers:
3-30mmf. or 7-45mmf. .45



VARIABLE CONDENSER,
air type, screwdriver shaft,
100, 125 mmf 80c;.....
.....15, 25 or 50 mmf..... .40



Submini **ELECTROLYTICS:**
25 mf .75
1,3,5 mf 55c; 10 mf 65c;



SUBMINI DISC CAPACITORS:
all sizes to .005 mf 15c;
01 mf 20c; .02 mf 29c;
.04 mf 45c; .05 49c; .1 55c



Trimmer, tubular,
1-8 mmf .35

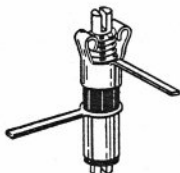

OSR type Quench coils \$1.65;
for MINI-MAC 1.25



Condensers & Resistors—
Most Sizes10

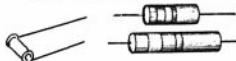

RF Mini Chokes 2, 10 or 20 Microh ea. .20
Mini 50 or 100 Microh.45

70uh .45



coil form adj.
Polyiron core 3/8" or 1/4" .25
wound .55



Wound Transmitter coil pr. .55



Pilot lights, 6V for
transmitter dummy load .15
Pilot lights, 2V
very low drain .15



Flea Clips 4 for .10



Battery Snap Connectors
Mini .24pr.



SIMULTANEOUS RUDDER AND ELEVATOR CONTROL!

COMPLETE COMBINATION OFFER....only....\$37.95
(Includes choice of escapement)

PILOT CONTROL	6 oz	\$12.95 ea
SELECTOR "4"	1 oz.	\$ 8.95 each
SLIM LINE SERVO	1 1/2 oz.	\$ 8.95 each
ESCAPEMENTS	1 oz.	\$ 5.95 each
(2 Pos. 3 Pos.)		
STEERABLE T.W. AND BRAKE KIT		\$ 1.85 each

AVAILABLE AT LEADING HOBBY SHOPS
OR DIRECTLY FROM US - INCLUDE 35c POSTAGE

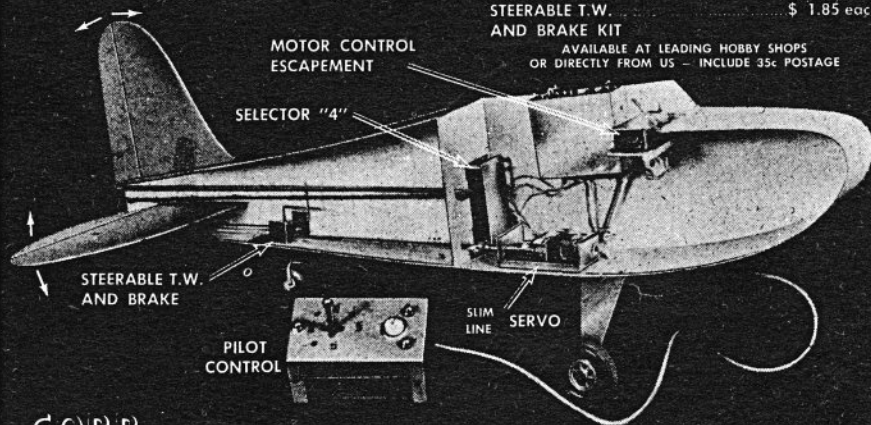

COBB

- SELECTOR "4" CAN BE USED WITH ANY RECEIVER!
 - PILOT CONTROL CAN BE USED WITH ANY TRANSMITTER!
 - "SLIM LINE" SERVO CAN BE USED WITH ANY RECEIVER!
- } OR USE WITH SELECTOR "4"

Fleaweight Hookup Wire—25 ft. (5 colors)	.35
Bonner WIRE 24 ft.. 8 colors	.60
Enameled copper wire	
#14 & #16 three feet	.10
Sizes 18, 20, 22 - ten feet	.15
Sizes 24 to 38 -fifteen feet	.15



Plastic Boxes	
1 3/4" x 2 1/8" x 1 1/8"	.20
1 7/8" x 1 7/8" x 7/8"	.15
1 1/8" x 1 1/8" x 7/8"	.15



Bakelite Boards for Receivers	.25
Drilled for Lorenz or Simple Single	.50
for Gazistor, Miller or MiniMac	.50

Deluxe insulated screw driver	.65
Insulated screw driver	.35



Experimenter's soldering iron 110V	.95
---	-----





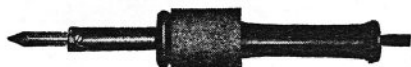



Mini soldering iron 110V	2.65
---------------------------------	------



Cabinets		
Black Crackle 12x7x6		2.95
" " " 9x6x5		2.25
12x7x6 drilled for model X1 Transmitter		3.95
Aluminum Case 7x5 1/2 x 7		1.65



HARDWARE

Solder lugs 6 for	.10	
Eyelets 1/8" 10 for	.10	
Shockmount	.15	
Alligator Clips Large & Mini each	.10	
Fahnestock clips 3 for	.10	
Tie Posts 2 1/2¢ per terminal		
Screw Terminal Mounting Strip 1¢ - 1 terminal 5¢ each additional terminal up to 4		